

Gunite Disc Wheel Hubs

Maintenance and Installation Manual



Your only single source for industry-leading wheel end solutions.
STEEL & ALUMINUM WHEELS | DRUMS | HUBS | ROTORS | SLACK ADJUSTERS

Gunite® offers a complete line of traditional ferrous disc wheel hubs for all of today's heavy-duty axle applications. In addition, Gunite offers a line of lightweight cast iron hubs which provide the advantage of substantial weight savings, combined with rugged dependability and maximum operating efficiency.

Like all Gunite products, Gunite disc wheel hubs are designed and tested to meet stringent industry standards for quality and performance. That's why Gunite offers one of the best warranties in the industry.

Typical Hub Mounting Configurations

Gunite disc wheel hubs are available in a wide range of designs to accommodate all common wheel and brake drum mounting configurations. Each hub style is designed so that the machined face of the hub automatically provides proper alignment of wheels and brake drums during installation.

Flange dimensions are carefully controlled in relation to the bolt circle for optimum component contact and support for the wheel. Therefore, it is recommended that NO bosses or scallops be used on the outside face of the wheel flange. Their use will substantially reduce wheel life.

Single Flange Nut

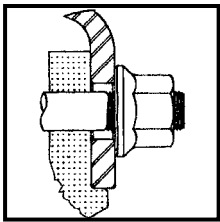

Single

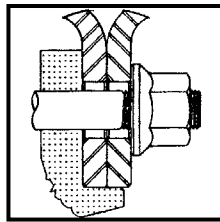

Dual

2 Piece Flange Nut Steel

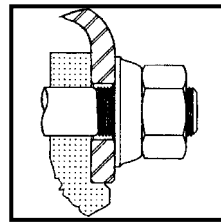

Single 1-1/8-16

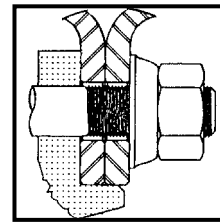

Dual

Ball Seat Steel

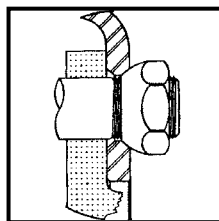

Single 1-1/8-16

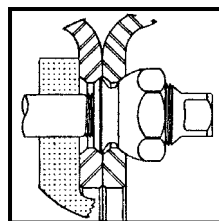

Dual

Ball Set Aluminum

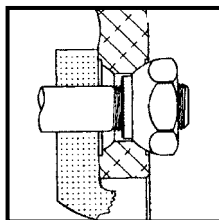

Single 3/4-16

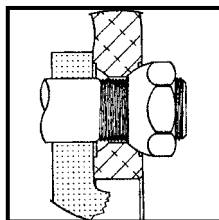

Single 1-1/8-16

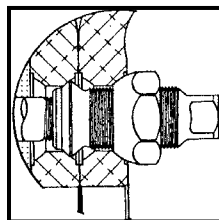

Dual

Hub Mounting Configurations

Gunite hubs are designed for mounting “fixed rim” wheels. This kind of mounting is recognized in the industry as the simplest, strongest, and most effective. It provides for positive torque transfer through the compression of all the mating surfaces, which are held in place with studs and cap nuts.

Gunite offers a full range of hubs designed for either inboard or outboard mounted wheel-end assemblies for front, drive, and trailer axles.

Outboard Mounting

In this assembly configuration, the brake drum is mounted on the outboard face of the hub, fitting over the wheel studs. Outboard mounting allows the brakes to be serviced without the removal of the hub, bearings and oil seal, which significantly reduces downtime during regular brake inspection and service.

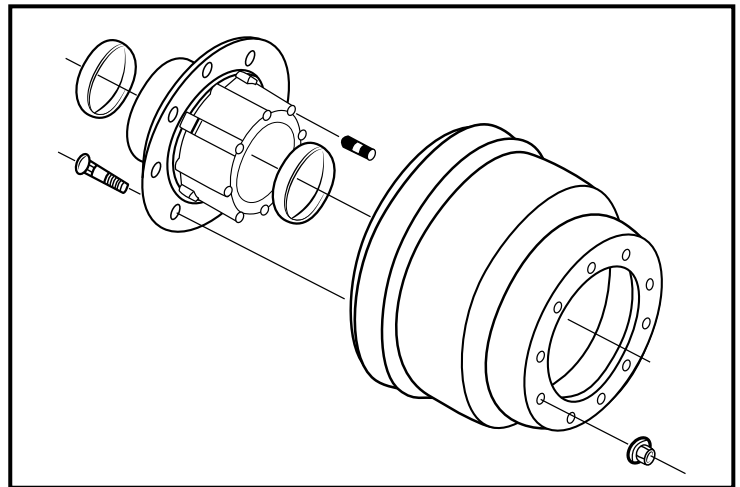

Outboard mounted hub and drum assembly.

Inboard Mounting

Disc brake rotors and inboard design brake drums are mounted on the inboard side of the hub flange and held in place by the wheel studs. On double-flange hubs, which are always mounted inboard, a separate set of bolts are used.

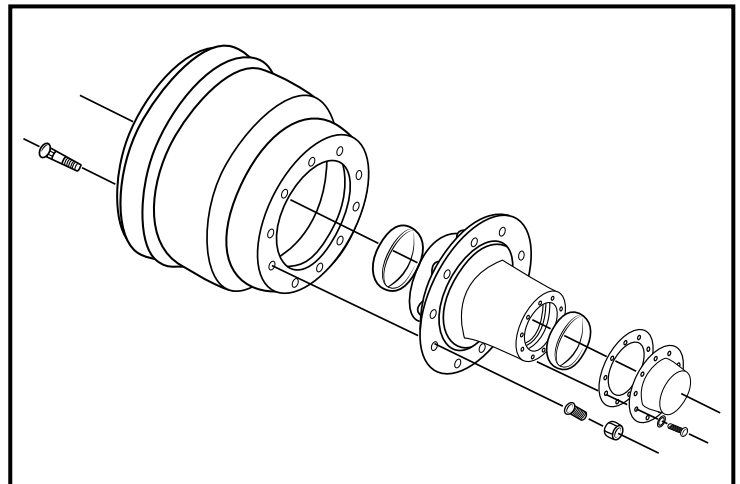

Inboard mounted hub and drum assembly.

Hub Piloted vs Ball Seat Drums

It is important to make sure that the correct hub and drum combination is used when replacing wheel-end assemblies. Incorrect or mismatched parts may result in loose or broken mounting studs or wheel-ends which can result in an accident. If you are unsure about the correct combination for your application, contact the manufacturer for the correct part numbers and styles.

Older ball seat mountings have a close fit between the drum stud holes and stud diameter. The drum is piloted on the hub pilot. The wheels are piloted on the studs using inner and outer cap nuts. (see Figure 1)

Hub piloted mountings have a close fit between the drum pilot and the machined pilot (continuous or interrupted) on the hub. The drum bolt mounting holes are larger than the stud diameter. The wheels and drum are piloted on the hub. (see Figure 2)

New drum designs will allow you to use the same drum for ball seat and hub piloted applications when matched with the proper hub. These new drums cannot be used with older hubs which have a different pilot diameter. Matching the drums with the proper hub is critical in providing and maintaining the support of the wheel-end.

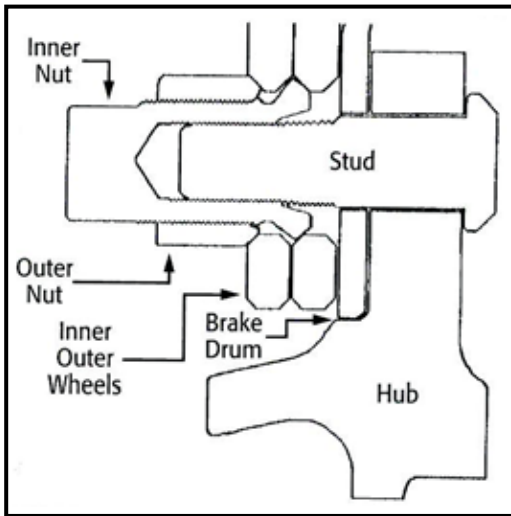

Figure 1 - A ball seat disc wheel mount

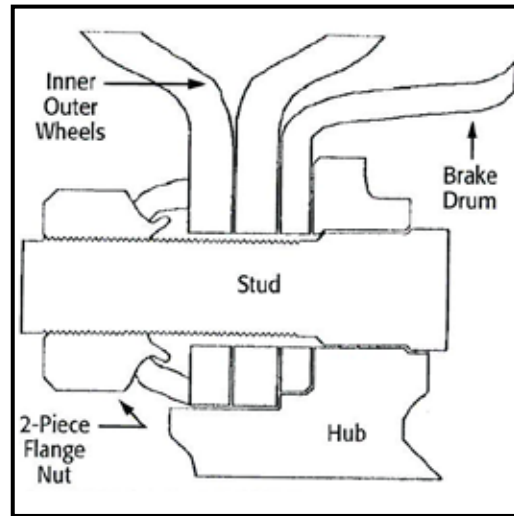

Figure 2 - A hub piloted disc wheel mount

Mounting Gunite Brake Drums on Hub Piloted Wheel-end Assembly

Gunite drums are designed with different pilot chamfers where the drum fits the pilot. If corrosion builds up behind the chamfer (point "X" in Figure 3) and a drum with a smaller chamfer (point "Y" in Figure 3) is installed without removing the corrosion from the hub, the drum will not set properly and the mounting flange may break when the assembly is torqued. Therefore, it is necessary that you thoroughly clean the hub mounting surface using a scrapper and wire brush before attempting to mount a new brake drum. **This is especially important if you are mounting brake drums on a wheel-end assembly using an aluminum hub.**

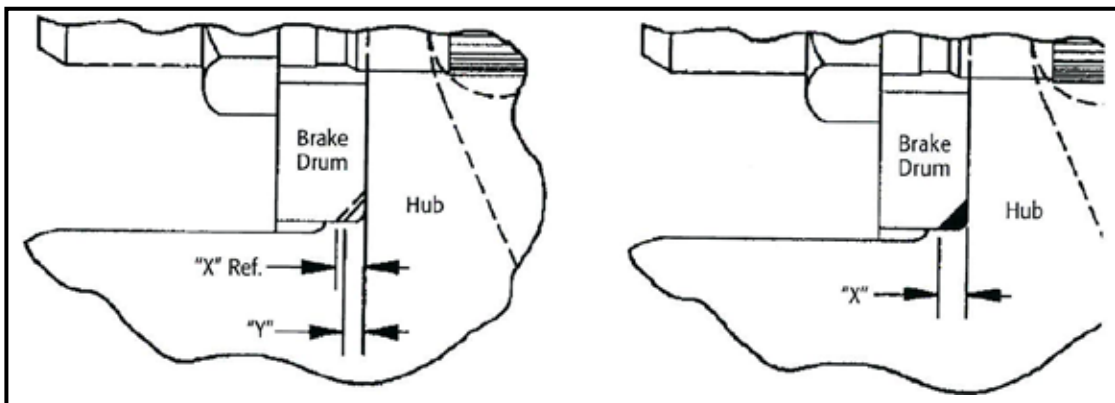

Figure 3 - A hub pilot chamfer

When and How to Inspect Disc Wheel Hubs

Proper Inspection and Maintenance of Disc Wheel Hubs

Regular and thorough inspection of disc wheel hubs should be part of every fleet's routine preventative maintenance program. While there are no set schedules for the inspection and maintenance of disc wheel hubs, it is advisable to inspect and perform any required maintenance or repairs at each tire change. It is also wise to incorporate hub inspection as part of the normal wheel-end inspection performed each time tire inflation is checked.

If a driver complains of wheel shimmy, tire kissing or excessive vibration, the entire wheel-end assembly including the hub, wheel and ALL associated hardware should be thoroughly inspected immediately.

Regular inspections and proper maintenance will help to provide safe, dependable operation while avoiding field service problems and unnecessary downtime.



Proper Cleaning

Grease, dirt, burrs, rust, paint and corrosion will adversely affect the hub's support of the wheel and can be a signal of more serious problems with the wheel-end assembly. Special attention must be paid to the proper cleaning of the mounting surface and the hub pilots during routine maintenance. It is also recommended that the ABS exciter ring be inspected for damage and cleaned at the same time, to ensure proper ABS system operation.

Using a wire brush, clean all of the machined surfaces of the hub, stud threads and ball seats as well as the exciter ring on ABS hubs.

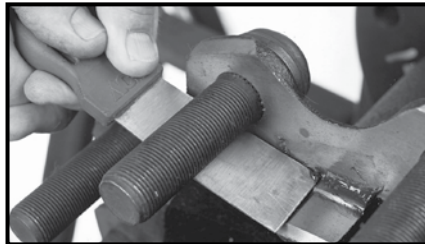

Carefully inspect the hub pilot surface to make sure that ALL foreign matter has been removed. If necessary, use a stiff blade scraper (as shown) to remove any remaining dirt, grease or contamination from the entire hub pilot surface.

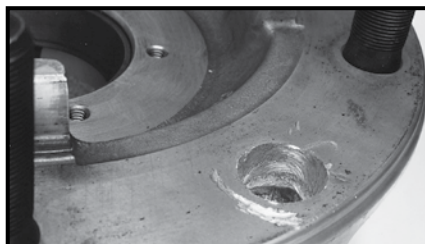

Worn Stud Holes

This condition is caused by the studs turning in the stud mounting holes due to insufficient torque on the back nut. If this condition exists, the hub **MUST** be replaced immediately.

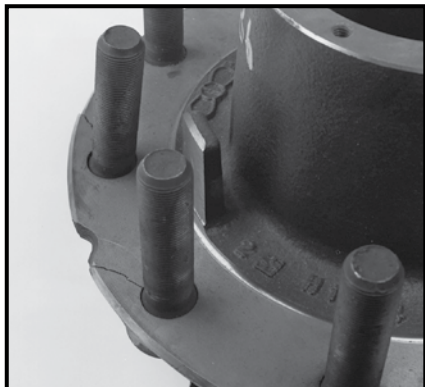

Broken and/or Bent Studs

Broken studs are caused by either loose cap nuts or overloading or a combination of both. **IF A BROKEN STUD IS FOUND, IT MUST BE REPLACED IMMEDIATELY ALONG WITH THE STUD ON EITHER SIDE OF IT. IF MORE THAN ONE BROKEN STUD IS FOUND, REPLACE ALL OF THE STUDS IMMEDIATELY.**

When replacing studs, make certain that the correct stud length is used. Studs which are too long for the application will not allow the back jam nut to seat firmly against the drum resulting in a loose drum. If the stud body length or "standout" is too long, the inner wheel can not be properly secured against the hub mounting face resulting in a loose inner wheel. Also, check the actual wheel load against the manufacturer's recommended wheel load to make certain that the correct components are being used for the application.

After the proper installation of the wheel-end components, check to make certain that the proper torque is applied to each nut following the recommendations on page 13.



Stripped Threads or Elongated Studs

Stripped threads or elongation of the studs is caused by the application of excessive torque. If this condition exists, the stud **MUST** be replaced following the stud installation procedure under Broken Studs on page 4.

After the proper installation of the wheel-end components, check to make certain that the proper torque is applied to each nut following the recommendations on page 13.



Loose Drum or Rotor

When a brake drum or rotor is found to be loose during regular inspection, the studs should be checked to make sure they are not too long for the application. The back jam nut must also be checked to make sure that it is firmly seated against the drum or rotor. If the studs are too long for the application or damaged, they **MUST** be replaced immediately, making sure that the proper length studs are installed. Follow the stud installation procedure under Broken Studs on page 4.



Loose Inner Wheel

If the inner wheel is found to be loose during routine inspection, the mounting studs should be checked for excessive stud "standout" beyond the hub mounting face. Excessive stud standout permits the inner nut to bottom out before it properly secures the wheel to the hub mounting surface. If this condition exists, the studs **MUST** be replaced immediately, using studs with the correct body length or "standout" Follow the stud installation procedure under Broken Studs on page 4.

Proper Stud Replacement and Installation

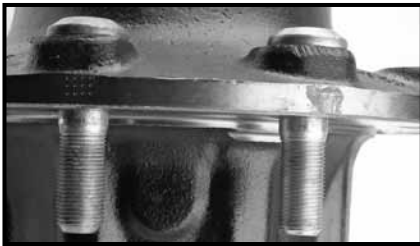

Proper Stud Replacement

When replacing worn or damaged studs, it is critical to make sure that the replacement studs have the correct dimensional characteristics for that particular hub and wheel-end assembly. Because the mounting flange thickness may vary from one hub design to another, care must be taken to ensure that studs used for replacement have the proper amount of standout for that wheel-end assembly.

Use of a stud with excess standout (as shown in the photo on the left) will not allow wheel-end assembly to be tightened properly during assembly. This will result in a loose wheel-end assembly and wheel-end failure.

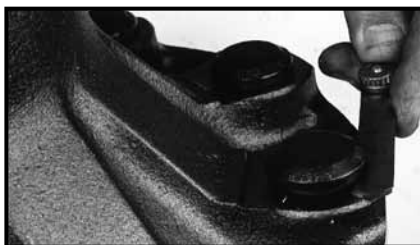

Proper Stud Installation

After replacing a stud or studs in an existing hub, a careful inspection should be made to ensure that the studs are properly installed and seated. The head of the stud should be seated tightly against the machined surface of the hub prior to any attempt to assemble the wheel-end. If the stud is not properly seated, as shown in the photo, the stud should be pressed into proper position using a press.

Do not attempt to pull the stud into place during assembly using the impact wrench. This can damage the hub, cause elongation of the stud or damage to the surface of the stud.



Replacement of Studs in Gunite Ductilite® Hubs

If a stud in a Gunite Ductilite® hub becomes damaged, it **MUST** be replaced with a Gunite Ductilite® hub stud. This stud is specially designed with an integral washer and dimensional characteristics necessary for proper installation. **Warning: Do not attempt to replace a stud from a Ductilite® hub with a standard stud or attempt to use commercial washers and a standard stud as a replacement assembly. Use of any stud other than the Gunite Ductilite® stud can result in wheel-end failure.**

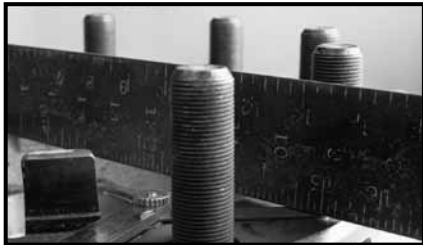

Worn or Damaged Mounting Surface

This condition can be identified by signs of wear on the mounting surface of the hub and is commonly caused by a loose wheel assembly or improperly installed outboard mounted brake drum. If the wheel assembly and/or drum is not properly installed and seated properly against the hubs mounting surface, excessive wear will appear on the mounting surface of the hub. If evidence of this condition exists, check to see if the mounting surface has been worn by placing a straight edge across the mounting surface. If the mounting surface is not touching the straight edge at any point along the edge, the mounting surface is damaged. If this condition exists, the hub **MUST** be replaced immediately (see Proper Installations Procedures page 8 of this manual). It is important that the proper torque levels and torquing procedures are followed when installing the new hub.

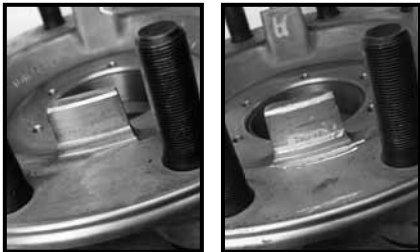

Shaved or Damaged Hub Mounting Pilots

Hub mounting pilots can be easily damaged as a result of careless handling and/or improper positioning of the brake drum and wheels during wheel-end assembly. If one or more of the hub mounting pilots are damaged as shown in the photo at the left, the hub **MUST** be replaced immediately. Attempting to mount a drum and wheels on a hub with a damaged hub mounting pilot **WILL** cause the assembly not to seat properly and could result in a loose wheel-end assembly.



Damaged ABS Exciter Ring

ABS compatible Gunite hubs are manufactured with a variety of exciter ring configurations as shown in the photos. It is important to inspect these exciter rings for damage and/or build-up of corrosion or road contamination during each routine wheel-end maintenance procedure. Care must be taken during routine wheel-end maintenance not to damage the exciter ring through careless handling of the hub.

If there is any apparent damage to the exciter ring, the hub must be removed and the exciter ring replaced immediately. If the hub has machined-in exciter teeth and these are damaged, the hub must be removed and replaced immediately. **OPERATION OF AN ABS EQUIPPED VEHICLE WITH DAMAGED OR CORRODED EXCITER RING(S) MAY CAUSE THE ABS SYSTEM TO OPERATE IMPROPERLY.**





Cracked Wheels

This condition can be identified by the development of cracks which appear on the face of the wheel and run between bolt holes or between bolt holes and hand holes or between bolt holes and center hole at one or more places around the wheel. Common causes of this condition may include loose wheel nuts, improper installation procedure (torque), a worn or damaged mounting surface on the hub, loose or broken studs, or a worn stud groove.

The wheel **MUST** be replaced immediately. The hub should be carefully inspected for excessive wear or damage to the mounting surface and/or studs. If the hub or other components are damaged, they **MUST** also be replaced immediately (see Proper Installation Procedures on page 8).



Rust Streaks

This condition is identified by the appearance of rust streaks radiating from the bolt holes on the wheel. This condition is the result of loose cap nuts and requires immediate service. The entire assembly, including the hub and studs, should be checked for damage as a result of the loose running condition. Any worn or damaged parts **MUST** be replaced immediately (see Proper Installation Procedures on page 8).

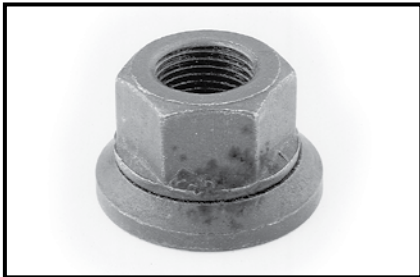

Seized or Frozen Two Piece Flange Nuts

This problem is indicated when the flange no longer turns on the nut. The cause of this problem can be the result of one or more factors such as corrosion, prolonged use, paint or lack of lubrication between the nut and the flange. If this condition occurs, the nut **MUST** be replaced with the correct two piece flange nut.

When installing the new flange nut, you must apply two drops of oil between the flange and the nut. **DO NOT** apply any oil to the interior threads. Follow the torquing recommendations of the manufacturer during and after installation. Avoid painting two piece flange nuts after they are installed on the wheel.



Cracked Two Piece Flange Nuts

This condition is indicated by ANY crack which appears on the flange of the nut. The cause of this problem can be the result of excessive torque, damage to the nuts and/or insufficient nut strength. If this condition occurs the nut **MUST** be replaced with the correct two piece flange nut. Inspect the wheel for cracks or damage to the mounting surface.

When installing the new flange nuts, make sure that they are designed for the application and meet the specifications of the original equipment manufacturer. Prior to installation, you must apply two drops of oil between the flange and the nut. **DO NOT** apply any oil to the interior threads. Follow the torquing recommendations of the manufacturer during and after installation. Avoid painting two piece flange nuts after they are installed on the wheel.



Spun Bearing Cup

Indications of this condition will most commonly be the appearance of lubricant on the wheel-end assembly including the hub and brake assembly due to seal failure. If outward signs of lubricant are present the wheel assembly should be removed and carefully inspected for seal failure and damage to the bearing cup. A spun bearing cup has a bluish discoloration to the bearing surface resulting from excess heat and signs of damage to the hub bore as a result of the friction between the bearing cup and the hub bore. If this condition exists, the hub **MUST** be replaced immediately.

Proper Installation of Gunite® Hubs

1. Clean and dry all parts to be used in the installation before beginning the procedure.
2. If you are using grease lubricated wheel bearings, fill the hub with grease to the inside diameter of the outer bearing cup. Also, fill the hub cap, and pack grease between the bearing rollers, cones and cage. Use an approved, heavy-duty multi-purpose lithium base (#2 grade) grease or synthetic grease.

If you are using oil lubricated wheel bearings, skip Step 2 and proceed to Step 3.

3. Place the inner bearing in the hub, and install the seal, following the installation procedure provided by the bearing manufacturer.

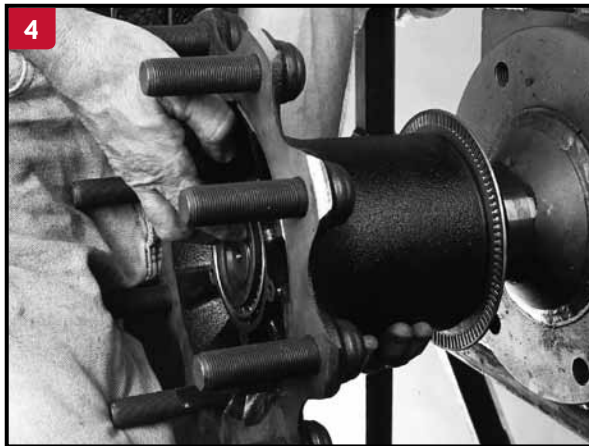

4. Install the hub by sliding it over the spindle being careful not to damage the oil seal. Position the outer bearing over the spindle and insert it into position.



5. Install the spindle nuts following specific torquing procedures available from the individual axle, bearing, and seal manufacturer. The approved industry standard requires a minimum of 0.001" to maximum of 0.005" end play for adequate seal and bearing performance. End play should be checked after adjustment, using a dial indicator on every wheel-end.

NOTE

Never use an impact wrench to adjust wheel bearings.

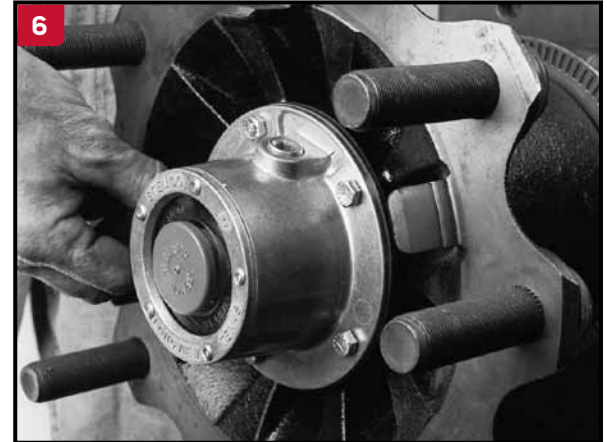

6. When installing non-drive or oil lubricated wheel bearings, fill the hub to the oil level line on the hub cap. Allow time for the lubricant to pass through the outer bearing before rechecking to verify the final oil level. Check the hub cap vent hole to make certain the vent hole is clean.



7. With drive hubs, check the oil level in the drive housing and add oil as required by the manufacturer's specifications. When installing drive hubs, position a new gasket over the drive studs and install the axle through the hub. Use drive cones as recommended by the axle manufacturer. Torque the nuts to the manufacturer's specifications using a sequence similar to that shown on page 11, Figure 6. If wheel hubs are equipped with oil fill/drain plugs, add a pint of oil to each wheel-end.

If hub does not have oil fill/drain plugs, each side of the drive axle must be raised a minimum of 8" to move the lubricant into the opposite wheel-end. After you complete this procedure, recheck the oil level and top off if required.

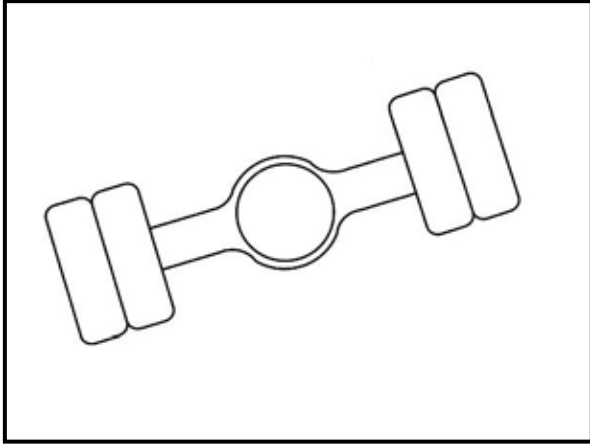

8. For applications using an outboard mounted brake drum, the drum should now be installed onto the hub pilot positioning it over the mounting studs. Check the drum carefully to make sure that it is installed properly and seated correctly before continuing with the wheel-end assembly.



NOTE

If you are installing a Gunite High Performance hub with a Gunite Tru-Set® system, refer to the Gunite High Performance maintenance and installation manual.

Installation of ABS Exciter Tone Ring Onto Gunite® Hubs

Gunite manufactures a wide range of aftermarket or replacement hubs for ABS applications. Depending on your application, these hubs will have a variety of ABS exciter ring configurations; powdered metal, stamped or machined-in, (as shown below.) Gunite hubs designed for powdered metal or stamped exciter rings do not have a factory installed ABS exciter ring. The exciter ring must be ordered separately and installed on the hub before the hub is installed on the axle. To find the correct exciter ring part number and ordering information, refer to the Gunite parts catalog. Locate the correct exciter ring part number for your hub part number and application.

Installation of powdered metal and stamped exciter rings requires that a specific installation procedure be followed. The procedure shown on page 10 in this manual is for the installation of a powdered metal exciter ring. A stamped exciter ring should be installed using a bearing press however, if a bearing press is not available, a stamped exciter ring may be installed using the powdered metal installation procedure.

CAUTION

When installing an ABS system, special ABS hubs must be ordered. Machining of older hubs to accommodate the installation of exciter rings can cause problems due to insufficient hub bore wall thickness. Machining an older hub with insufficient hub bore wall thickness could result in cracking, causing bearing failure and possible wheel loss.



Powdered Metal Tone Ring



Stamped Tone Ring



Machined Exciter Teeth

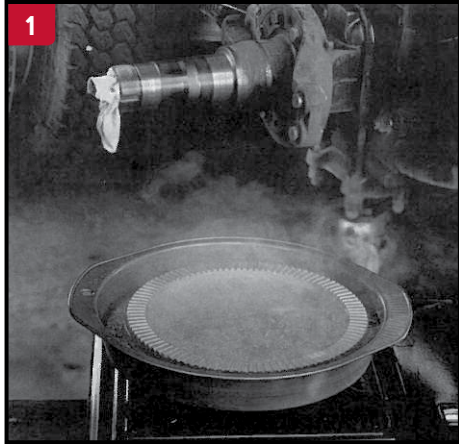

1. Heat the exciter ring by submerging it in boiling water or placing it in an oven at 250 degrees for approximately 15 minutes. DO NOT ATTEMPT TO HEAT THE EXCITER RING WITH A TORCH AS THIS CAN DAMAGE THE RING AND CAUSE IMPROPER INSTALLATION.

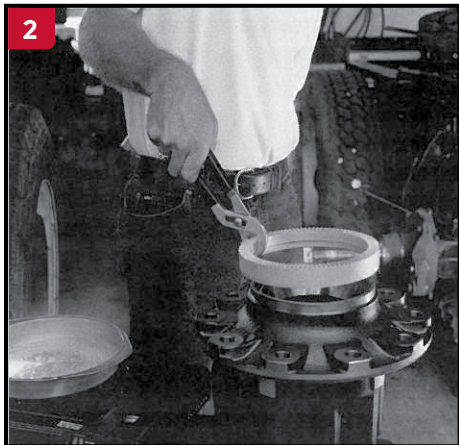

2. Using pliers, remove the exciter ring from the boiling water or oven and center it on the machined area of the hub bore.

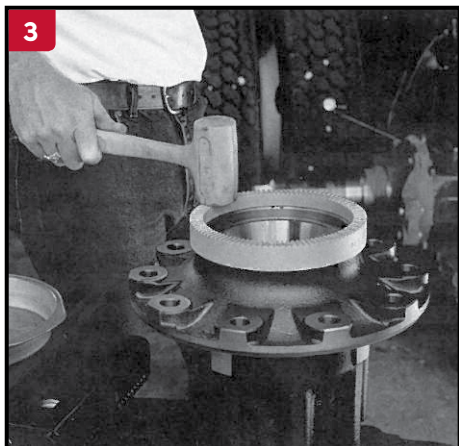

3. While the exciter ring is still hot, make sure that it is properly centered on the machined surface. Using a rubber mallet, tap the exciter ring until it bottoms out around the machined surface on the hub.

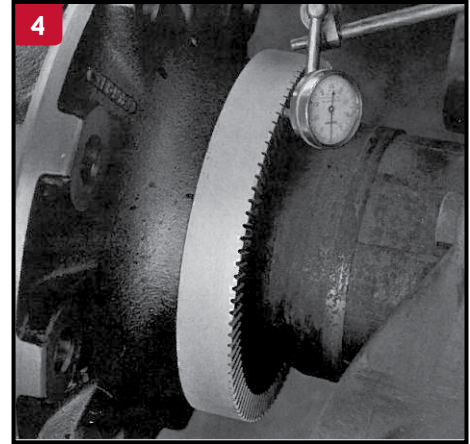

4. Check the hub to make sure that the exciter ring is properly installed. To do this, install the hub on the axle and place a dial indicator with a magnetic base so the dial indicator is against the exciter teeth.

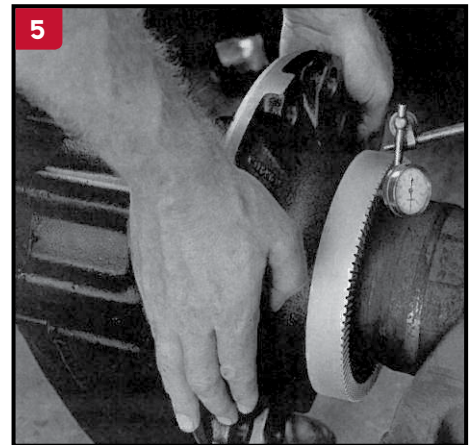

5. Rotate the hub to check the exciter teeth runout. The runout should be less than .008".

NOTE

Be advised, on vehicles with an ABS system, tone rings cannot be removed from one manufacturer's hub and installed on a hub from a different manufacturer. Tone rings are precision fit to each manufacturer's hub design. Failure to do so can result in serious accident or injury. Gunite tone rings are designed specifically for Gunite disc wheel hubs and meet stringent industry standards for quality and performance.

Proper Wheel-End Component Installation Procedures

Careless mounting is the major cause of hub, wheel and rim problems. Attention to the proper installation of the hub and wheel assemblies will help to avoid unnecessary service problems and downtime while assuring you of maximum service life and safe operation.

1. Before you begin the installation, check each part for damage making sure that all studs, nuts, hub and wheel mounting surfaces are clean and free from grease. Use a wire brush to clean dirt, rust, burns, or paint off the mounting surfaces. Replace any damaged or defective parts before beginning the installation.



2. Mount the single or inner dual wheel over the stud, being careful not to damage any of the threads on the studs. Figure 4 illustrates how a single wheel should look when mounted. Figure 5 shows the proper mounting configuration for a dual wheel.

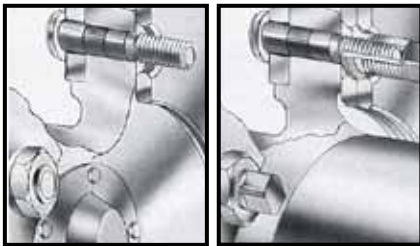

Figure 4 - Single wheel installation **Figure 5** - Dual wheel installation

3. Draw up the nuts alternately in the sequence shown in Figure 6. DO NOT tighten them fully at this time. Stud and cap nut threads should be clean and dry; no oil should be used beyond the first three threads.

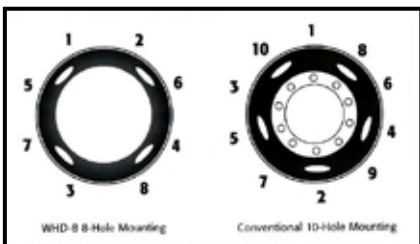

Figure 6 - Proper tightening and torquing sequence

4. It is extremely important that the condition of each nut be checked before installation. Figure 7 shows a nut which is in good condition, while figure 8 shows a cap nut which exhibits signs of scarring and galling. Any nut showing signs of damage such as the one in Figure 8, should be discarded and replaced with a new nut.



Figure 7



Figure 8

If two piece flange nuts are used, any nut showing excessive corrosion between the nut and the flange or any nut with a crack in the flange, as shown in Figures 9 and 10, should be discarded and replaced with a new nut.

It is also important that you have the correct fasteners. It is extremely important that various nuts are NOT interchanged or intermixed. Nuts used in a hub piloted system CAN NOT be used in a stud piloted system.

Once the nuts are in place, each nut should be checked for uniform seating.



Figure 9



Figure 10

5. Tighten and torque the nuts fully, using the same alternating sequence as shown in Figure 6. Tighten them only to the recommended torque level as shown in the chart on page 13. Use a torque wrench to verify the proper torque, especially if an air wrench or bar wrench has been used to tighten the nuts.



6. When replacing studs on a Gunitite Ductilite® hub you must use the specially designed stud shown in Figure 10. This stud has an integral washer, which is necessary for proper installation of the wheel-end assembly. **Do not attempt to replace a worn or broken stud in a Ductilite® hub with a conventional stud. Doing so may cause damage to the hub and will result in an improperly installed wheel-end assembly causing wheel-end failure.**



Figure 10

Hub Piloted vs Ball Seat Drums

It is important to make sure that the correct hub and drum combination is used when replacing wheel-end assemblies. Incorrect or mismatched parts may result in loose or broken mounting studs or wheel-ends which can result in an accident. If you are unsure about the correct combination for your application, contact the manufacturer for the correct part numbers and styles.

Older ball seat mountings have a close fit between the drum, the stud holes and stud diameter. The drum is installed on the hub pilot. The wheels are piloted on the studs using inner and outer cap nuts. (see Figure 11)

Hub piloted mountings have a close fit between the drum pilot and the machined pilot (continuous or interrupted) on the hub. The drum bolt mounting holes are larger than the stud diameter. The wheels and drum are piloted on the hub. (see Figure 12)

New drum designs will allow you to use the same drum for ball seat and hub piloted applications when matched with the proper hub. These new drums cannot be used with older hubs which have a different pilot diameter. Matching the drums with the proper hub is critical in providing and maintaining the support of the wheel-end.

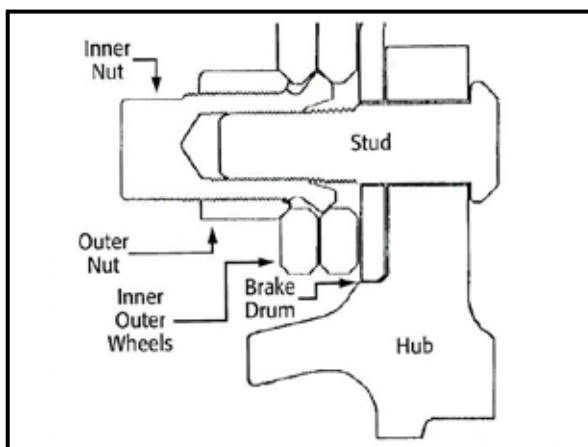

Figure 11 - A ball seat disc wheel mount

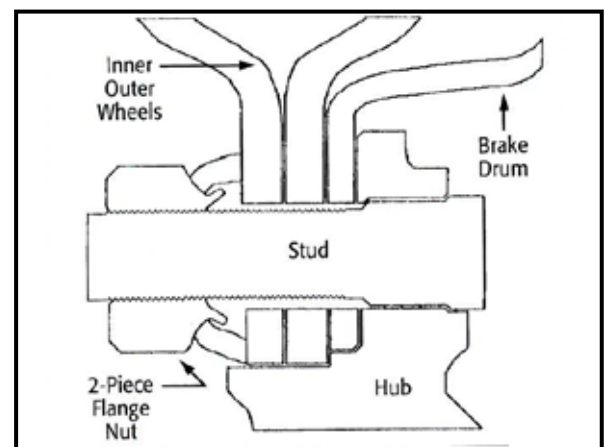

Figure 12 - A hub piloted disc wheel mount

Mounting Nut Installation Torque

| Nut Type | Wheel Stud Thread Size | Torque Level Ft. Lbs. (dry) |
|-----------------------|------------------------|-----------------------------|
| Ball Seat | | 450 - 500 |
| Two Piece Flange Nuts | M22 X 1.5 M20 X 1.5 | 400 - 500 280 - 330 |

NOTE: Never lubricate wheel, nut ball seats or mounting faces. If lubrication is desired, it must be used sparingly only to the threads of the studs and/or nuts.

Disc Wheel Mounting Torque

| Mounting Type | Nut Thread | Torque Level Ft. Lbs. (oiled)* |
|-----------------------------|-------------|--------------------------------|
| Hub piloted with flange nut | 11/16" - 16 | 300 - 400 |
| | M20 X 1.5 | 280 - 330 |
| | M22 X 1.5 | 450 - 500 |

* Apply two drops of motor oil to the point between the nut and the flange and two drops of motor oil to the last two or three threads at the end of each stud.

| Nut Type | Wheel Stud Thread Size | Torque Level Ft. Lbs. (dry) |
|--|------------------------|-----------------------------|
| Stud piloted, double cap nut standard type 7/8" radius | 3/4" - 16 | 450 - 500 |
| | 1-1/8" - 16 | 450 - 500 |
| Stud piloted, double cap nut heavy-duty type 1-3/16" radius | 15/16" - 12 | 750 - 900 |
| | 1-1/8" - 16 | 750 - 900 |
| | 1-5/16" - 12 | 750 - 900 |

NOTE: Never lubricate wheel, nut ball seats or mounting faces. If lubrication is desired, it must be used sparingly only to the threads of the studs and/or nuts.

NOTE

If using specialty fasteners, consult the manufacturer for recommended torque levels.

Tightening wheel nuts to their specified torque is extremely important. Under tightening will result in loose wheels which can damage the wheel, studs and hub and can result in wheel loss. Over tightening can damage the studs, nuts and wheels resulting in loose wheels as well.

Regardless of the torquing method used, all torque wrenches, air wrenches or other tools used should be calibrated periodically to ensure that the proper torque is applied.

WARNING

Insufficient mounting torque can cause wheel shimmy, resulting in damage to parts and extreme tire tread wear. Excessive mounting torque can cause studs to break and discs to crack in the stud hole areas.

WARNING

Some hub piloted and stud piloted wheels may have the same bolt circle pattern and may be mistakenly interchanged. Care must be taken never to mix or interchange parts between hub piloted and stud piloted wheel systems. Each mounting system requires specific components to allow for the proper mating of all components. It is important that the proper components are used with each type of mounting, and that the wheels are fitted to the proper hubs.

If hub piloted wheel components (hubs, drums, wheels, fasteners) are mixed with stud piloted wheel components, loss of torque, broken drums, studs, cracked wheels and possible wheel loss can occur since these parts are not designed to work together.

Ball Seat Mounting Applications

| Number of Studs | Bolt Circle Diameter | "A" Dimension | |
|-----------------|----------------------|---|---|
| | | Ferrous Wheel | Aluminum Wheel |
| 6 | 8.75" | Single 1.25" min. Dual 1.31" - 1.44" | Single 1.50" min. Dual 1.31" - 1.44" |
| 10 | 8.75" | Single 1.25" min. Dual 1.31 - 1.44 | - |
| 10 | 11.25" | Single 1.25" min. Dual 1.31" - 1.44" | Single 1.68" min. Dual 1.31" - 1.44" |

I.S.O. Metric (Hub Piloted) Applications

| Number of Studs | Bolt Circle Diameter | "A" Dimension | |
|-----------------|----------------------|--------------------------|--------------------------|
| | | Ferrous Wheel | Aluminum Wheel |
| 8 | 275mm | Single 48mm Dual 62mm | Single 54mm Dual 79mm |
| 10 | 285.75mm | Single 48mm Dual 62mm | Single 59mm Dual 84mm |
| 10 | 335mm | Single 48mm Dual 62mm | Single 59mm Dual 84mm |

Stud Standout

When changing studs or hubs, it is important to have the correct stud standout to ensure proper wheel mounting. Stud standout appears as dimension "A" in the two diagrams below.

Outboard Drum Mounting

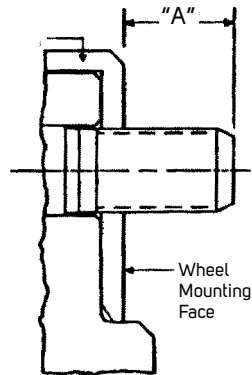

Inboard Drum Mounting

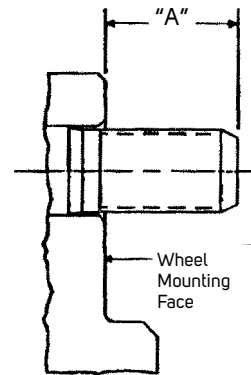

Check the Hubs on New Equipment

When taking delivery of new equipment which uses disc wheels, there are three steps that need to be taken to ensure that your equipment is suited to your application and that it will perform safely during the normal operation.

Verify Hub Load Rating

It is important to verify the hub load rating on new equipment to make sure that it will satisfy the actual load capacity requirements. Some operators install greater capacity tires to increase the payload. This does not increase the load rating of the hubs. Operating your equipment under extreme conditions or with loads greater than the rated capacity of the hubs may cause damage to the hub and affect vehicle performance.

Check the Mounting Nut Torque

After the new truck, tractor or trailer has traveled the first 50 to 100 miles, the hub/wheel assembly will “seat”, causing the mounting nuts to lose some of their initial torque. In order to assure proper and safe operation, the following procedure MUST be followed.

If two piece flange nuts are used, re-torque to the proper values as shown on page 13.

If cap nuts are used, proceed using the following three step procedure.

1. Loosen the outer cap nuts.
2. Tighten the inner cap nuts to the proper torque as shown in the torquing chart on page 13.
3. Retighten the outer cap nuts to the proper torque as shown in the torquing chart on page 13.

If this procedure is followed as recommended, the cap nuts should not lose torque during normal operation. It is still necessary for the cap nuts torque to be checked regularly as part of a complete preventative maintenance program.

Establish a Good Preventative Maintenance Program

Establishing a good preventative maintenance program will ensure that your equipment performs efficiently and safely. Familiarize your operators and service personnel with the guidelines and procedures recommended in this manual as part of that regular maintenance program.

ACCURIDE WHEEL END SOLUTIONS (AWES) LIMITED WARRANTY TO FILE A WARRANTY CLAIM, CALL (800) 869-2275 ext 1

Accuride Wheel End Solutions (AWES) warrants to the original purchaser that its products are free from defects in material and workmanship. The limited warranty time-frame (reference table below) is based on the date of product manufacture and shall be void if the product is altered, modified, misapplied, misused, neglected, repaired or not maintained in accordance with the instructions printed in the product-specific Accuride Wheel End Solutions' Safety & Service Manuals⁽²⁾.

GENERAL PRODUCT OVERVIEW

| Product Type | 6 years/ 1,000,000 miles ⁽¹⁾ | 5 years/ 60 months | 5 years/ 500,00 miles ⁽¹⁾ | 4 years/ 400,000 miles ⁽¹⁾ | 3 years/ 350,000 miles ⁽¹⁾ | 3 years/ 300,000 miles ⁽¹⁾ | 2 years/ 200,000 miles ⁽¹⁾ | 1 year/ 12 months | Limited Warranty ⁽²⁾ |
|---|--|--|--|--|---|--|--|--|-------------------------------------|
| Accuride Aluminum Wheels ⁽²⁾ | | Industry Standard Aluminum Wheels Duplex® Aluminum Wheels ACCU-SHIELD® Wheels ACCU-ARMOR® Wheels | | | | | ACCU-FLANGE™ Wheels | | |
| Accuride Steel Wheels ⁽²⁾ | | Extra Service Wheels™ (ESW) Styled Steel Wheels Tubeless Wheels and Demountable Rims EverSteel™ ⁽⁶⁾ | | | | | | Duplex® Steel Disc Wheels Duplex® Demountable Rims Tube-Type Wheels & Demountable Rims Light Truck Wheels Steel Bolt-Together Specialty Wheels | |
| Gunite Slack Adjusters ⁽²⁾ | Over-The-Road/Line Operated Trucks and Trailers ⁽⁴⁾ | | Over-The-Road/Line Operated Trucks and Trailers ⁽³⁾ | School Bus/City Delivery Vehicles ⁽⁴⁾ | | School Bus/City Delivery Vehicles ⁽³⁾ Severe Service: Garbage/Refuse Trucks, Fire Trucks, Logging, etc. ⁽⁴⁾ | Severe Service: Garbage/Refuse Trucks, Fire Trucks, Logging, etc. ⁽³⁾ | | |
| Gunite Hubs ⁽²⁾ | | | TRU-SET™ Trailer | | TRU-SET™ Front/Steer TRU-SET™ Rear/Drive | | | | Industry Standard Hubs |
| Gunite Brake Drums ^{(2) (5)} | | | | | | | | | Industry Standard Brake Drums |
| Gunite Disc Brake Rotors ^{(2) (5)} | | | | | | | | | Industry Standard Disc Brake Rotors |
| Gunite Spoke Wheels ⁽²⁾ | | | | | | | | | Industry Standard Spoke Wheels |

⁽¹⁾ Time or miles, whichever occurs first. Time is measured from date of manufacture.

⁽²⁾ See Remedies and Limitations of Remedies and refer to appropriate Accuride Wheel End Solutions guide for additional limited warranty condition details: Accuride Rim/Wheel Safety & Service Manual, Gunite Heavy-Duty Brake Drums, Gunite Automatic Slack Adjuster Service Manual, Gunite Disc Brake Rotors Maintenance Manual, and Gunite Disc Wheel Hubs, High-Performance Hubs, Spoke Wheels Maintenance & Installation Manual, and EverSteel™ Refinishing Criteria.

⁽³⁾ Manufactured prior to April 6, 2015

⁽⁴⁾ Manufactured on or after April 6, 2015

⁽⁵⁾ Limited warranty for life of product.*

* "Life of product" means such period until the product has reached its maximum/minimum brake surface limitation. Product remains subject to the terms and conditions in this limited warranty, including the provisions on additional product warranty criteria and remedies and limitation of remedies.

⁽⁶⁾ EverSteel™ wheels are covered by a limited warranty to be free of "rust damage" for sixty (60) months from the date of manufacture indicated on the wheel. Rust damage is defined as rust sufficient to require refinishing as determined by Accuride in accordance with Accuride's technical bulletin W2.043 EverSteel™ Refinishing Criteria. The EverSteel™ warranty does not cover, and expressly excludes, rust in the crevice between the disc and the rim.



ACCURIDE WHEEL END SOLUTIONS (AWES) LIMITED WARRANTY TO FILE A WARRANTY CLAIM, CALL (800) 869-2275 ext 1

ADDITIONAL PRODUCT SPECIFIC LIMITED WARRANTY CRITERIA

Wheels: The above warranty shall be void if the product is used with improper tire sizes, inflation pressures, or exceeded load ratings. The above warranty shall be void if the product is not properly maintained in accordance with the Accuride Rim/Wheel Safety & Service Manual. The above warranty also does not cover defects resulting from corrosion (except as noted herein in the EverSteel™ limited warranty's terms and conditions), other non-Accuride components, accident, excessive speed or other abnormal or severe operating conditions.

ACCU-ARMOR®, ACCU-SHIELD®, ACCU-FLANGE™, and EVERSTEEL™: AWES does not cover the following conditions: (i) Any damage in the areas of the mounting surfaces, such as the area under the mounting nuts, the area in contact with hubs or drums and the area in contact with other wheels in dual position, (ii) Any damage due to cleaning, including damage from the use of abrasives, abrasive brushes, steel wool, scouring pads, strong chemicals, or corrosion, and/or (iii) Any damage to the wheel finish due to wheel/tire assembly, removal, balancing weight, misuse, or chipping, whether by contact with road obstacles such as stones, gravel, curbs, barriers, signs, tire changing equipment or otherwise. ACCU-SHIELD® products are not covered for corrosion. ACCU-FLANGE™ products, after washing, can have wheel polish or carnauba wax applied with a 100% cotton cloth. The EVERSTEEL™ limited warranty is void with respect to, and expressly excludes, wheels that have been refinished or refurbished and/or used without Accuride Wheel Guard®. The EVERSTEEL™ warranty, due to its long period, expressly excludes and expressly does not cover appearance, paint integrity, or paint adhesion to the wheels due to chipping effect. AWES recommends cleaning wheels with mild soap and water.

Standard Brake Drums, Spoke Wheels, Disc Wheel Hubs, Automatic Slack Adjusters, and Hardware: The above warranty shall be void if (i) any goods have exceeded AWES' acceptable wear limits or have been subjected to accidents or abnormal conditions of use, temperature, moisture, dirt or corrosive matter, or (ii) the product fails as the result of another manufacturer's product. The TRU-SET™ disc wheel hub requires the use of a seller-approved hubcap and lubricant.

REMEDIES AND LIMITATIONS OF REMEDIES

In the event of any material breach of the above limited warranties, AWES agrees to repair or replace,* at its sole option, without charge any and all of its warrantable product that fail during normal use and service due to defects in material and/or workmanship, all subject to the original purchaser providing written notice of the alleged breach within 30 days of failure. Time is of the essence herein, and original purchaser's failure to provide written notice to AWES within the required time of any alleged breach of the foregoing warranty will release and discharge AWES from any obligation or liability for that breach of warranty. In no event will AWES be liable for any other costs associated with the replacement or repair of product covered under this warranty, including labor, installation or other costs incurred by customer.

* - NOTWITHSTANDING THE ABOVE, THE SOLE REMEDY UNDER THE EVERSTEEL™ WARRANTY SHALL BE THE PAYMENT OF US \$45 IF A WARRANTABLE PRODUCT FAILS DURING NORMAL USE AND SERVICE DUE TO DEFECTS IN MATERIAL AND/OR WORKMANSHIP. No repair or replacement is included in the EverSteel™ warranty. Only one claim per wheel may be paid under the EverSteel™ warranty. Payment of the \$45 discussed above is Accuride's sole and exclusive obligation under this warranty. Accuride will not be responsible to organize or conduct any refinishing, repair, or replacement under this warranty, and in no event will Accuride be liable for special, incidental or consequential damages.

Customer must timely report the breach of warranty and demonstrate warrantability under the then applicable procedures during the warranty period. The remedies set forth herein shall be the sole and exclusive remedies available to the original purchaser so that AWES repair, replacement, or payment as described above is a fulfillment of all AWES obligations. AWES SHALL NOT BE LIABLE FOR ANY CONSEQUENTIAL OR INCIDENTAL DAMAGES OF ANY KIND. FURTHER, UNDER NO CIRCUMSTANCE SHALL AWES BE LIABLE FOR DAMAGES BEYOND THE PRICE OF THE GOODS PURCHASED BY THE ORIGINAL PURCHASER, WHETHER IN CONTRACT, IN TORT OR UNDER ANY WARRANTY OR OTHER USE.

AWES reserves the right to request product return as a condition of reimbursement and/or payment. Return expense may be paid by AWES or may be reimbursed to the original purchaser if product is found to be warrantable. No goods are to be returned to AWES without a Returned Goods Authorization (RGA). If AWES determines that any of the returned goods are non-warrantable, AWES reserves the right to charge the original purchaser for the recovery of all transportation costs and expenses incurred in examining, processing and handling such goods. Any controversy or claim that customer may wish to bring that is arising out of or related to this limited warranty or breach hereof must be commenced in writing within 30 days of notification of warrantable status or shall be deemed to be waived.

Any product deemed non-warrantable is the property of the original purchaser and can be returned to the original purchaser upon its request and at its sole cost and expense. Should the non-warrantable item(s) not be reclaimed, AWES will disposition the product no sooner than 30 days after original purchaser notification has been made.

For all warranty related questions, please contact your AWES warranty administrator at (800) 869-2275 Option 1 or submit questions or claims to warrantyadmin@accuridecorp.com.

THE ABOVE WARRANTY IS THE SOLE AND EXCLUSIVE WARRANTY GIVEN BY AWES AND IS IN LIEU OF ALL OTHER WARRANTIES EXPRESSED, STATUTORY OR IMPLIED, INCLUDING WARRANTIES OF MERCHANTABILITY AND FITNESS FOR A PARTICULAR PURPOSE, ALL OF WHICH ARE EXPRESSLY DISCLAIMED BY AWES. IN NO EVENT SHALL THIS WARRANTY BE DEEMED TO COVER INCIDENTAL, SPECIAL, INDIRECT OR CONSEQUENTIAL DAMAGES OF ANY KIND.

NOTES



Your only single source for industry-leading wheel end solutions.
STEEL & ALUMINUM WHEELS | DRUMS | HUBS | ROTORS | SLACK ADJUSTERS

(800) 677-3786 | (815) 964-3301 | accuridewheelendsolutions.com
Gunitite | 302 Peoples Avenue | Rockford, IL 61104-7092